

Product brochure

# Power Xpert 9395 UPS

225–1100 kVA



*Powering Business Worldwide*



**An Eaton Green Product**

## Introduction and overview

For more than 40 years, Eaton® has been dedicated to delivering the most technologically advanced products for our customers' mission-critical applications—a commitment exemplified by the Power Xpert™ 9395 UPS. With an unprecedented level of power performance, reliability and energy savings, the state-of-the-art 9395 has raised the bar in three-phase power protection technology.

The 9395 delivers a wide scope of superior customer-driven benefits unmatched by competitive UPS solutions, including:

### Leading sustainability

- Highest efficiency ratings lower utility costs
- Lowest total cost of ownership and lifecycle carbon footprint
- Smallest footprint and weight
- Lowest transportation and installation costs

### Stronger power performance

- Lowest input to THD enhance compatibility with upstream power systems
- Lowest output THD
- Optimum generator sizing
- PFC power supply compatible

### Highest reliability and availability

- Powerware Hot Sync® wireless paralleling
- Superior battery management
- Inherent redundancy
- Scalable architecture that adapts to increasing power requirements

### Robust manageability

- Superior control and connectivity

### Key applications

- Large data centers
- Server farms
- Telecommunication installations
- Internet service providers
- Transportation systems
- Security operations
- Broadcasting and entertainment
- Process control equipment
- Financial systems
- Credit card operations
- Healthcare
- Industrial systems
- Multiple medical imaging units

## The reliable solution

Providing high availability for your critical systems at all times, the 9395 was designed with numerous technological advancements that create an unprecedented level of reliability while emphasizing serviceability—lowering MTTR and enhancing availability.

### Double-conversion design offers the highest protection possible

Unlike some other commercially available UPS technologies, the double-conversion design completely isolates output power from all input power anomalies and delivers 100-percent conditioned, perfect sine-wave output—regulating both voltage and frequency. Even when presented with the most severe power disturbances, power output remains stable. Output voltage THD is held within two percent of nominal specification for linear loads, and within five percent for nonlinear loads—making the 9395 ideal for supporting equipment that's sensitive to a distorted voltage input. Additionally, the 9395 excels at supporting leading power factor loads, which are becoming more prevalent in new or updated data centers. The 9395 handles leading loads, down to 0.9 power factor, without de-rating.

### Inherent redundancy option

Surveys focused on efficiency in data centers reveal that UPSs are often under-loaded—frequently at less than 50 percent. To capitalize on this trend and create even greater reliability, you have the option to configure the 9395 with inherent redundancy. Traditional UPS manufacturers can't deliver this additional availability without adding a more costly second UPS module.

**Inherent redundancy option: When at or below 50 percent capacity, the 9395's uninterruptible power modules (UPMs) automatically act as N+1 redundant systems.**



9395 550 kVA

## Measuring power performance: efficiency, power factor and THD

Power performance, which is measured by system efficiency, output power factor and THD, is the foundation of the 9395. It's the UPS's robust combination of these three elements that make it stand out as the premier UPS in its class. The table below demonstrates how the 9395 with Energy Saver System (ESS) compares to competitive UPS models. Most manufacturers must use input filters, which lower their efficiency rating, but the 9395 doesn't require them to obtain excellent input THD.

As an example, a large data center (2.2 MVA) would realize the following savings by using a 9395 with ESS compared to traditional N+1 systems:

- Additional energy savings: 2,917 MW hours
- Additional carbon savings: 2,523 tons
- Annual cost savings: \$315,708

### 9395 (WITH ESS) ANNUAL POWER SAVINGS VS. THE COMPETITION

Model	kVA rating	Full load annual power savings	Half load power savings	Cooling power savings at half load	Total savings at half load (power and cooling)
Eaton Power Xpert 9395	1100				
vs. Competitor A	1000	\$66,300	\$35,700	\$23,800	\$59,500
vs. Competitor B	1000	\$20,400	\$15,300	\$10,200	\$25,500

Costs calculated at industry average of \$.10 per KWH.

### 9395 POWER DENSITY VS. THE COMPETITION (N+2 SYSTEM)

Model	kVA rating	KW per sq. foot	Annual space cost savings (at \$1000 per sq. foot)
Eaton Power Xpert 9395	1100	25.5	
vs. Competitor A	1000	16.6	\$15,000
vs. Competitor B	1000	16.9	\$20,000

## Energy Saver System

To demonstrate the importance of total system efficiency in relation to load level, the graph below shows how efficiency generally dips as load level decreases. In general, manufacturers list an optimal efficiency rating at full load. In reality, however, most three-phase UPSs operate in the range of 20-40 percent load. As a result, it's extremely important to evaluate the efficiency of a UPS at lighter loads as this graph depicts. The optional ESS technology operates at 99 percent efficiency even at low load levels, giving end users real energy savings.

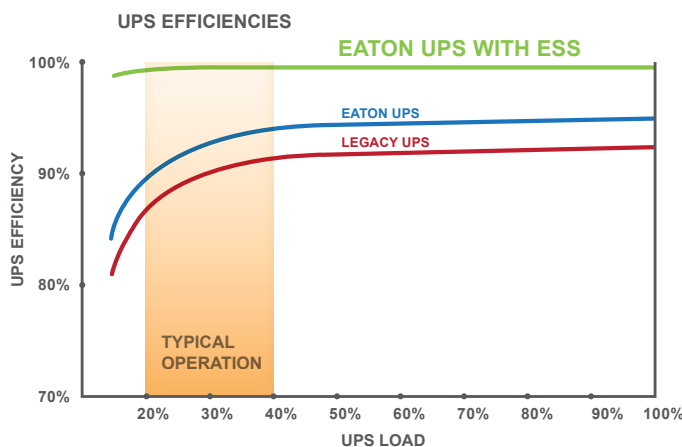

*"The 9395 alone provides about a 10 percent gain in efficiency over our previous unit. And with ESS, of course, that goes all the way to 99 percent, which would be about a 15 percent increase. It's huge."*

*- Kevin Dorhmann, chief technology officer, CoSentry*

## 9395 UPS Gets SMaRT®

The 9395 UPS is the first power quality product to receive a Sustainable Materials Rating Technology (SMaRT®) Gold certification. As a result, the UPS can contribute to Leadership in Energy and Environmental Design (LEED®) points for buildings and projects seeking LEED certification. SMaRT products must offer multiple environmental and economic benefits such as cost savings, design innovation, product differentiation, and also meet life cycle environmental performance requirements.

Eaton's SMaRT Gold certification is the next step for Eaton in documenting the environmental benefits associated with the production and use of the 9395. The 9395 has already passed rigorous testing to receive Eaton's Green Leaf designation, which verifies that the 9395 offers exceptional, industry-leading environmental benefits to customers, consumers and our communities

The SMaRT Gold certified 9395 can contribute points to two LEED Credit Categories: Innovation in Design Credit and the Energy and Atmosphere Credit. To learn more about credit categories and the USGBC LEED certification system, visit [www.usgbc.com/LEED](http://www.usgbc.com/LEED).



## Powerware Hot Sync technology: the culmination of power reliability and systems availability

In systems with multiple uninterruptible power modules (UPMs), the 9395 leverages the synchronization, load sharing and selective trip capabilities of Eaton's patented Powerware Hot Sync technology. These capabilities are integral to the ultimate systems availability that's the primary requirement for any parallel UPS configuration.

### Key design features of Hot Sync systems

- No system-level single point of failure.
- Paralleled UPMs operate completely independently; one module can't affect or interfere with the others – no domino-effect scenario.
- No added circuitry is required for parallel operation; any standard UPS can be used in a parallel system without modification.
- This patented and proven technology has been successfully deployed in thousands of systems around the world.

## Sync Control technology

Sync Control ensures that the output of two or more separate UPSs (single modules or parallel systems) remain in phase with one another so static transfer switches connected between the separate distribution paths may change state seamlessly when necessary.

## Static Auto Tie

The Static Auto Tie (SAT) system enhances reliability even further so full load transfers can be made autonomously. The SAT system adds a single wrap-around static switch to the tie breaker in the Hot-Tie system, then adds intelligent controls so a power protection system made up of two or more separate UPS systems can **automatically transfer entire** loads in the event of failure of one side of an A/B distribution system. This eliminates the need for numerous downstream static switches and costly wiring.

In the SAT configuration displayed in the diagram below, a SAT circuit between the outputs of the two UPS modules automatically transfers the loads from one to the other as necessary. This less complex, dual-path architecture streamlines the distribution system to eliminate series switching elements and reduce the potential downtime of single power cord loads by up to 50 percent. As a result, the SAT architecture offers a number of benefits, including:

- Reduced capital expenses and installation costs
- Eliminated need for traditional downstream static transfer switches
- Increased system reliability and efficiency
- Decreased maintenance requirements
- Reduced raised floor space requirements

## Fully deployed Static Auto Tie configuration

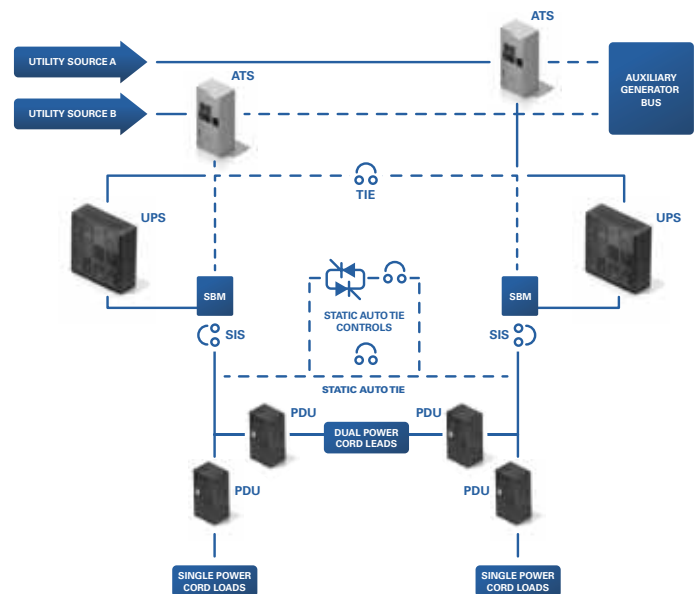

## Easy Capacity Test

The 9395 has the unique ability to test its entire power train under full load stress without the requirement of an external load. With no load connected, the 9395 is able to test all its power-handling components, including the rectifier, inverter, contactors, fuses, power busses, cabling, batteries, bypass (static switch), magnetics, and filter capacitors. The net result of this innovative load test is that there are no load banks to rent, no temporary load connections to make, and no wasted energy. Furthermore, the 9395 has the ability to test the upstream bypass input breaker (BIB), the rectifier input breaker (RIB), and all the electrical cables between them. This load test feature can take the place of most traditional load bank tests to save you time and money during startup and commissioning. Eaton field technicians are trained to use this load testing capability during a startup service to ensure optimum calibration, maximum efficiency and inherent redundancy.

As a result, they can produce a report that verifies these tests and the overall performance of the UPS. All preventive maintenance visits included with PowerTrust Service Plans for the 9395 include this unique load testing feature to ensure that the UPS is operating optimally. It also validates the performance of an installed UPS and can simulate various operations and power transfers.

## Easy Capacity Test Power Flow

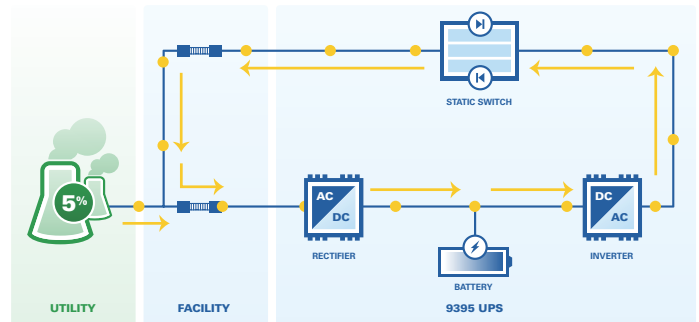

## Scalable, redundant architecture meets current and future requirements

The 9395 combines the reliability and redundancy of a multi-module UPS into an integrated, pre-wired solution. With a unique, flexible design that provides scalability, the UPS can adapt to future changes in load demands and new requirements for higher reliability without requiring the purchase of an additional UPS. For example, the 9395 UPS enables you to add a 275 kVA UPM in the field for N+1 redundancy or capacity.

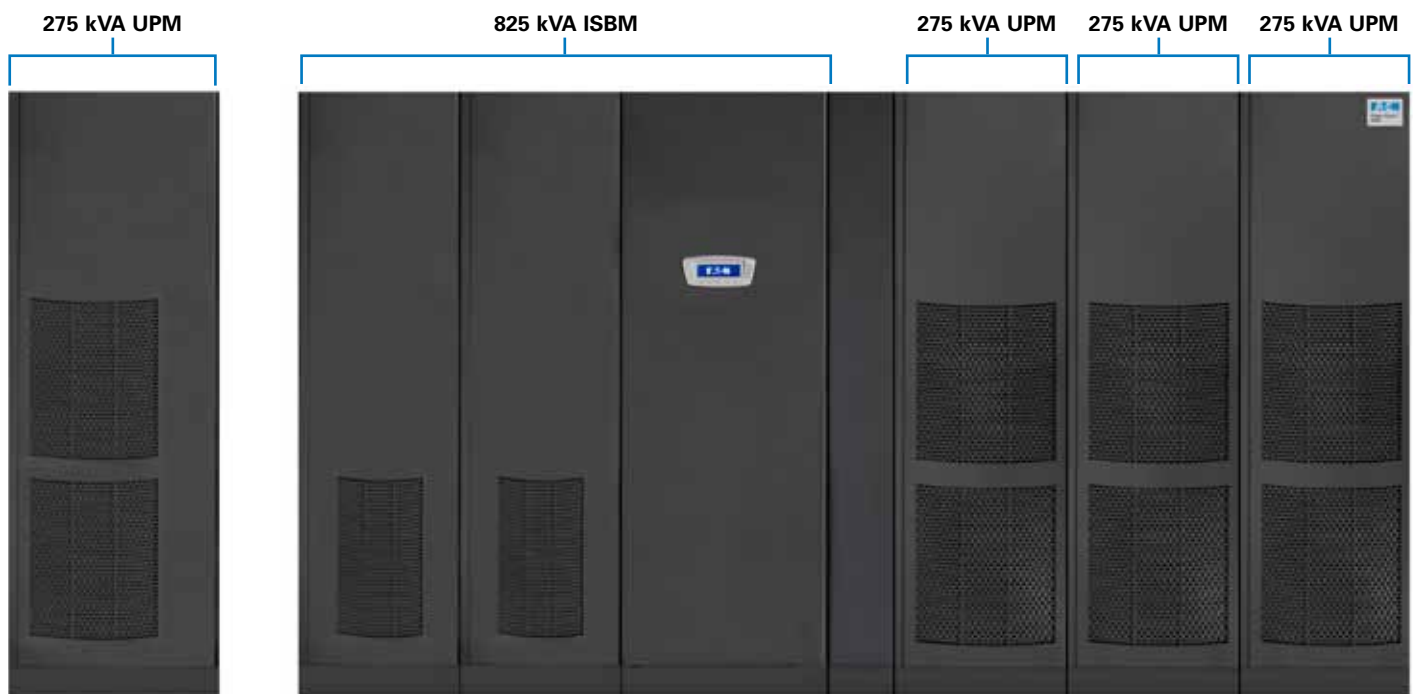

9395 825 kVA



## System Bypass Module: unparalleled flexibility for your parallel UPS system

Four decades of experience in paralleling large UPS systems is incorporated in this newest System Bypass Module (SBM) from Eaton. For use with multi-module paralleled 9395 systems, the switchgear enclosure encompasses a centralized static switch. You can order it with either momentary or continuous duty rating, along with system-level circuit breakers for bypass, UPS system output, feedback protection and maintenance, or “wrap-around” bypass functions. Four ratings are available as standard: 1200A, 2000A, 3000A and 4000A. The customizable cabinet features a 10-inch color LCD screen to display status for up to 32 of the UPM modules, and provides an intuitive user operation interface.

The touch-sensitive SBM display shows a graphical view of the entire system one-line diagram, with intuitive controls and quick access to key information like battery time remaining, event/alarm history, system metering for kW and kVA, voltage, current, frequency, power factor and phase balance. The SBM also provides terminal connections for system-level building alarm inputs and relay outputs. To enhance flexibility, the system controls/monitoring section may also be deployed in custom or third-party switchgear, to ensure that the most reliable monitoring and user-friendly controls are included with alternative power circuit components.

The Eaton SBM incorporates the following hallmarks of Powerware Hot Sync paralleling technology, which has defined Eaton’s most mission-critical UPS configurations for decades:

- Multiple UPS synchronization and load sharing accomplished without dependence on inter-module wiring networks.
- Peer-to-peer architecture that operates the parallel system without the need for master load share or master synchronization controls. The system operates with NO centralized control circuit.
- Control Area Network (CAN) bus architecture to ensure precise load sharing <3% at full system load.
- No single point failure in powertrain or control.



Eaton 10-inch LCD SBM screen

## Concurrent maintenance: higher availability

With 9395 redundant models, Eaton field technicians can completely isolate and service a redundant module while the other module carries the load—**without going to bypass for service**. The 9395 also features a completely front-accessible design and can be installed against walls or back-to-back in multi-module configuration. This service-friendly design enhances maximum uptime and availability.

## Ease of installation

Traditional multi-module installations require up to three times the footprint for power modules and tie cabinets. In contrast, the 9395 is a completely integrated large system that incorporates multiple power modules and system switchgear on factory pre-wired bases. Since everything is pre-wired, cabling costs and installation time are significantly reduced.



9395 550 kVA

## 825 kVA N+1: 9395 vs. Competitor

### Competitor solution

125 sq. ft.

19,215 lb system weight\*

Extensive site wiring

\*Excluding batteries

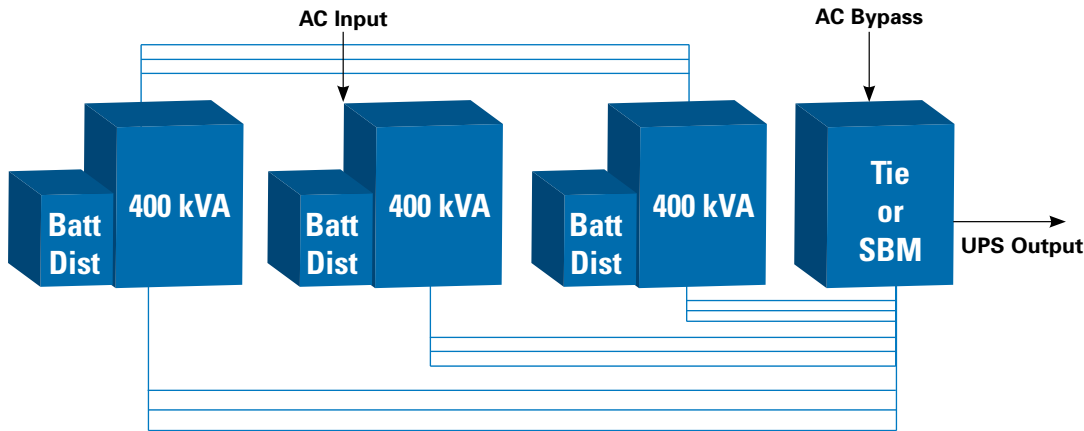

### 9395 solution

39 sq. ft.

6,365 lb system weight\*

Minimal site wiring

\*Excluding batteries

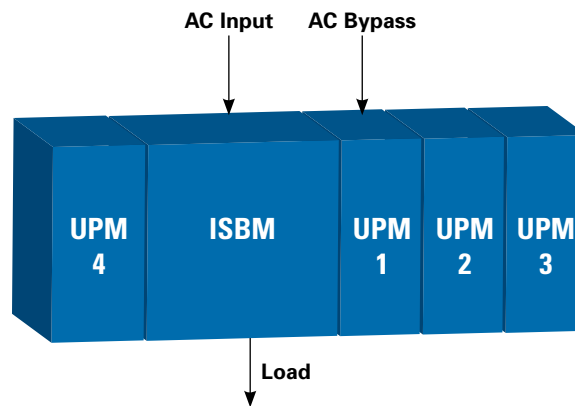

### Greatly reduced footprint

The 9395 UPS offers the smallest footprint and lowest weight of any UPS in its class—50 to 60 percent less than competitive units. In fact, the 9395 fits a redundant design into the same footprint as a traditional, non-redundant UPS. The 9395's smaller footprint not only reduces your total cost of ownership, but also provides a UPS that's approximately half the weight of legacy and competitive systems. As a result, freight costs are much lower and the smaller size and weight of the UPS make it much easier to handle. In fact, the 9395 fits easily through all doors and can be transported on freight elevators. Unlike some larger and heavier systems, there's no need to dismantle it to fit it on elevators or through doorways, which can cause significant delays and increase costs.

### Minimized cabling requirements and expense

In an integrated system such as the 9395, multi-module systems arrive pre-wired with no need to perform costly and time-consuming inter-unit cabling for power and communications between modules and the system bypass unit. Considering the increasing cost for raw materials such as copper, this savings can be significant. Cabling enters the 9395 UPS from either the top or bottom of the cabinet to provide easier and more flexible installation.

## Batteries: the heart of every UPS

When a utility power outage causes a UPS to switch to battery power, it's imperative that those batteries are healthy, charged and up to the task. Improper battery management is the number one cause of downtime. Many UPS batteries on the market today are constantly trickle-charged—a process that degrades the battery's internal chemical composition over time, reducing potential battery service life by as much as 50 percent. To address this, the 9395 uses a sensing circuit and innovative three-stage charging technique to significantly extend battery service life and optimize recharge time. In addition, temperature-compensated charging monitors temperature changes, and adjusts the rate of charge to prolong battery life.

## Monitor batteries for optimum readiness

Advances in firmware and digital technology enable the 9395 to offer sophisticated battery monitoring and management features you might expect to find only on expensive add-on systems, including:

- Remaining battery runtime is calculated by using system loading and trended battery discharge data, plus internal sensing points for voltage and current data.
- Battery circuit test- a periodic full-load test of the battery string is done to ensure there are no open circuits or weak cells that would jeopardize battery performance and system availability.

In addition to these integrated monitoring features, we offer one year of secure, remote monitoring to provide 24x7 real-time monitoring of more than 100 UPS and battery alarms with eNotify. This real-time information is critical to help you make management decisions, from scheduling preventive maintenance to determining the best way to reduce loads during an outage.

By ensuring optimal battery health and availability, battery monitoring features raise the reliability of the 9395 beyond any other UPS in its class.

*"We've been very pleased with the support we receive whenever we call. Because we rely heavily on the unit, and since we don't have the onsite expertise or staff to maintain it, having a service plan gives us additional peace of mind to know that it is being well maintained."*

*- Dean Kokko, wager operations manager, TVG*

## Service and support enhance performance

Eaton recognizes that superior power reliability requires flawless execution from our service team. Included at no extra charge with every 9395 is:

- 24x7x365 startup service and customer training
- One-year limited factory warranty<sup>1</sup>
- Service protection plan 24x7 coverage, eight-hour response (upgrade to four- or two-hour where available), parts and labor, unlimited on-site emergency response support
- eNotify Remote Monitoring Service: 24x7 critical alarm notification and monthly reports on UPS and battery health
- 24x7 technical support access



In addition to the warranty and first year of on-site coverage, Eaton offers a wide variety of support agreements for continued preventive and emergency response maintenance. PowerTrust Service Plans include:

- UPS and battery scheduled preventive maintenance
- Parts and labor coverage for electronics and/or batteries
- Factory-trained technicians with genuine Eaton parts and diagnostic tools
- eNotify Remote Monitoring Service
- Available coverage: 24x7, eight-four-two-hour response, or 8x5 next business day response
- 24x7 technical support access

<sup>1</sup> Refer to the Eaton Corporation Limited Factory Warranty for three-phase UPS products for specifications, limitations, and terms. Service and support specifications may vary by country.



## eNotify Remote Monitoring Service

All PowerTrust Service Plans include Eaton’s eNotify Remote Monitoring Service, enabling Eaton service technicians to remotely monitor your UPS and batteries using one-way emails. With technical experts available to respond immediately and resolve many issues remotely, eNotify features 24x7 real-time monitoring of 100+ UPS and battery alarms.

The eNotify service provides you with monthly reports detailing the ongoing health of your 9395 UPS. The Customer Monitoring Report delivers information on your unit’s voltages, loads, and external factors such as temperature and humidity. Additionally, the report provides information about the attached batteries and system availability. All these factors contribute to the Relative Health Index (RHI) score that allows you to compare your unit’s health to Eaton’s optimum operating levels.

Proactive monitoring is also included. Upon receipt of both status and event e-mails, anomalies are checked for incoming parametric or event data logs. If an anomaly is detected, Eaton analysts further study the data for possible impending failures and take appropriate action. The following critical alarms are provided by eNotify:

- UPS output power will turn off after the configured delay period
- Low battery alarm present
- UPS hardware fault detected
- UPS battery completely discharged
- UPS inverter fault detected
- UPS internally bypassed
- UPS output has been turned off
- UPS shutdown imminent alarm condition exists
- Failure of one or more fuses has been detected
- A relay, contactor or breaker has failed

The eNotify Remote Monitoring Service provides confidence that Eaton is continually watching your 9395 and combines its technical resources and field technicians as needed to quickly respond to critical alarms.

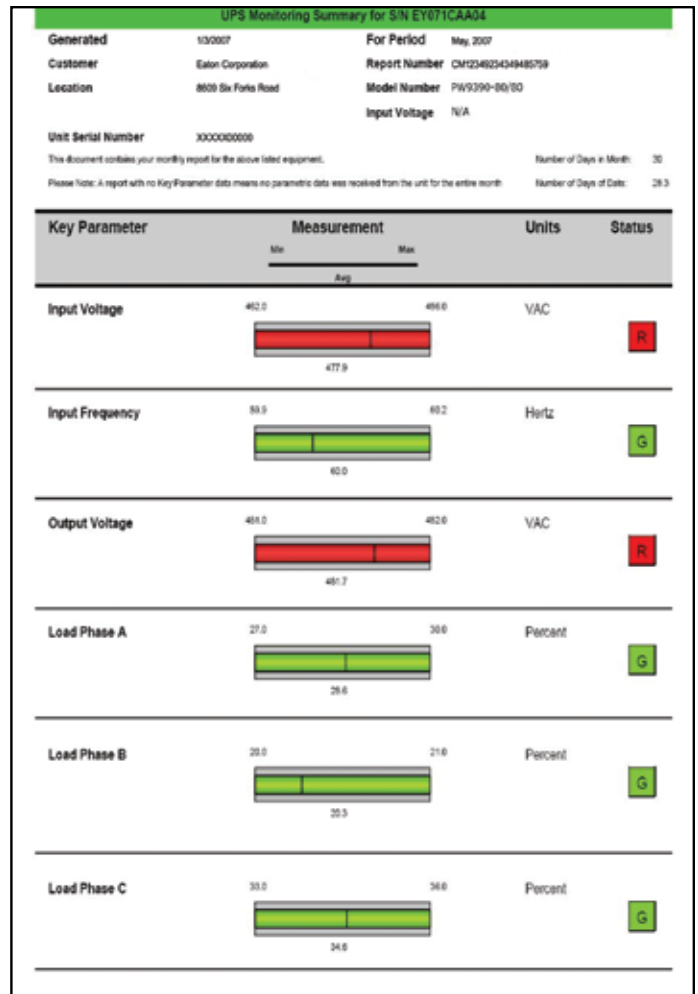

Sent via email to as many as six site contacts, the eNotify monthly Customer Monitoring Report provides a summary of the top 10 performance and environmental parameters, battery events, availability percentage, and comparative status against recommended specification.

*“With eNotify, any alert immediately goes to our Network Operations Center, as well as to the people that we would turn around and call anyway. With Eaton, the technician is in the truck and on the road before they even hear from us — and that’s a big deal.”*

- Kevin Dorhman, CoSentry CTO

## Monitoring, control and reporting capabilities

### Expanded solution: Ethernet connectivity

The Power Xpert® Gateway UPS card allows you to connect your 9395 UPS directly to your Ethernet network and the Internet. With its built-in Web server it provides information on one or more UPS modules remotely, without additional software.

#### Benefits:

- Remotely monitors the following critical data:
  - UPS energy usage
  - Load percentage
  - Battery, alarm and load segment status
  - THD and output power
- Configure shutdown agent and set up UPS shutdown schedules, as well as UPS test and control remotely
- Automatically maintains data, interval and event logs with time stamp for power and energy parameter analysis
- Integrates your UPS into existing building management or network management systems

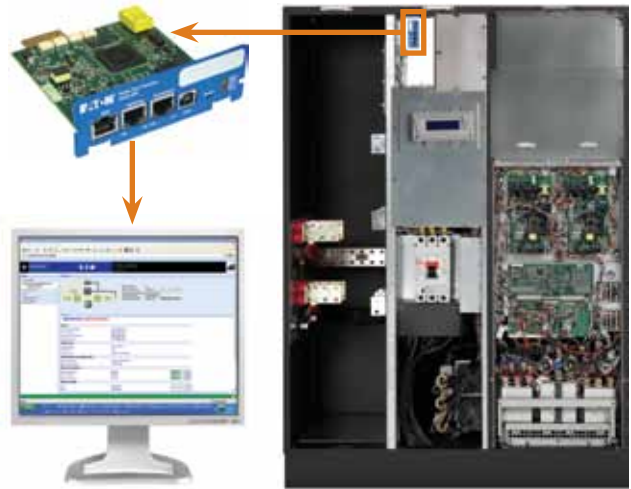

**Ethernet connectivity**



**9390 and 9395 UPSs**

### Complete solution: Power Xpert Software and Reporting

Power Xpert Reporting takes your UPS, data center, and site monitoring to the next level. It allows you to see past individual measurements, trend graphs and events. It analyzes the complex data from multiple sites and boils it down into easy-to-understand graphical reports.

#### Benefits:

- At-a-glance analysis information, quickly see
  - Power capacity reserves
  - Potential high-power users
  - Where power is consumed and usage patterns
  - Current, voltage, and harmonic power quality event patterns and reoccurrence trends over time
  - Temperature and humidity readings
- Know your PUE and DCiE immediately and how they change with energy saving efforts
- Know your IT vs. non-IT energy consumption
- Ten report templates meeting various energy and green reporting needs
- Assistance with LEED certification

### Powerful solution: Power Xpert Software

Once your 9395 is on the network via the Power Xpert Gateway UPS card, you can centralize and analyze data with Power Xpert Software.

#### Benefits:

- Monitor your entire data center or power system giving you the big picture of power quality and energy usage to proactively address issues
- Graphical and at-a-glance user views allowing simultaneous monitoring of multiple UPSs and other equipment
- Allows the full capability to monitor Powerware Hot Sync systems
- Data, interval, and event logging with time stamp for power and energy parameters from your 9395 UPSs, as well as power distribution and other power system equipment

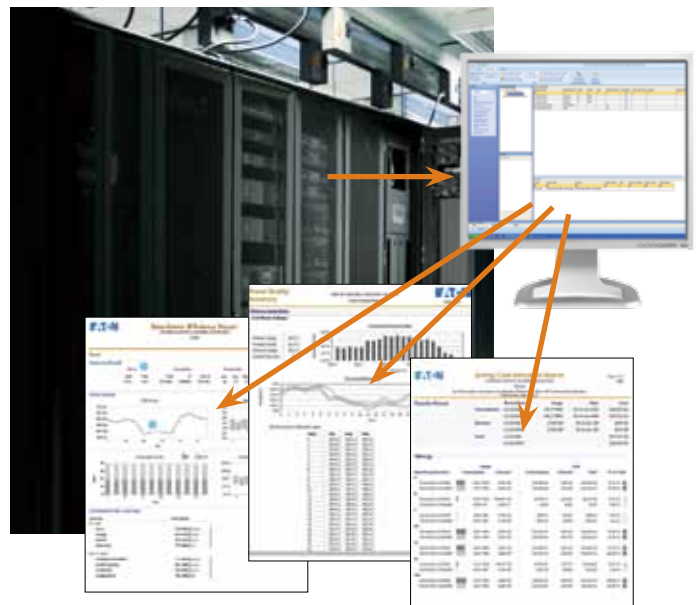

**Sample reports as generated by Power Xpert Reporting**

## Core components

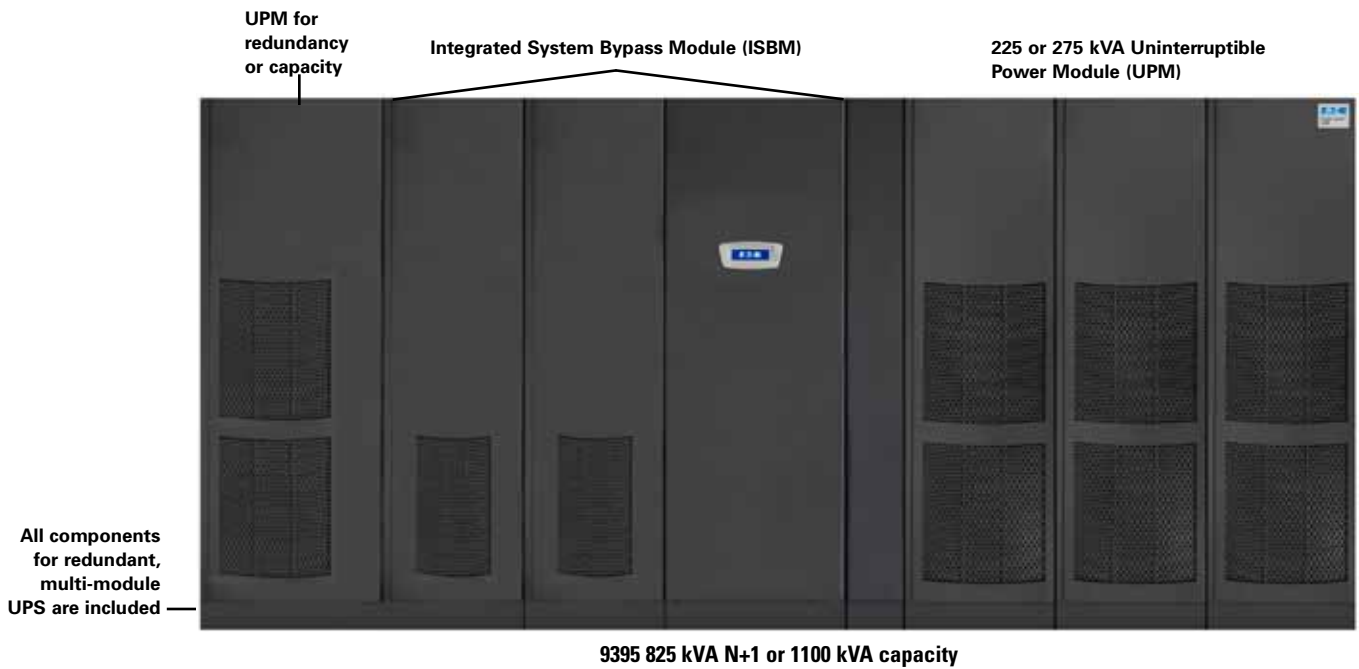

## A closer look inside the 9395

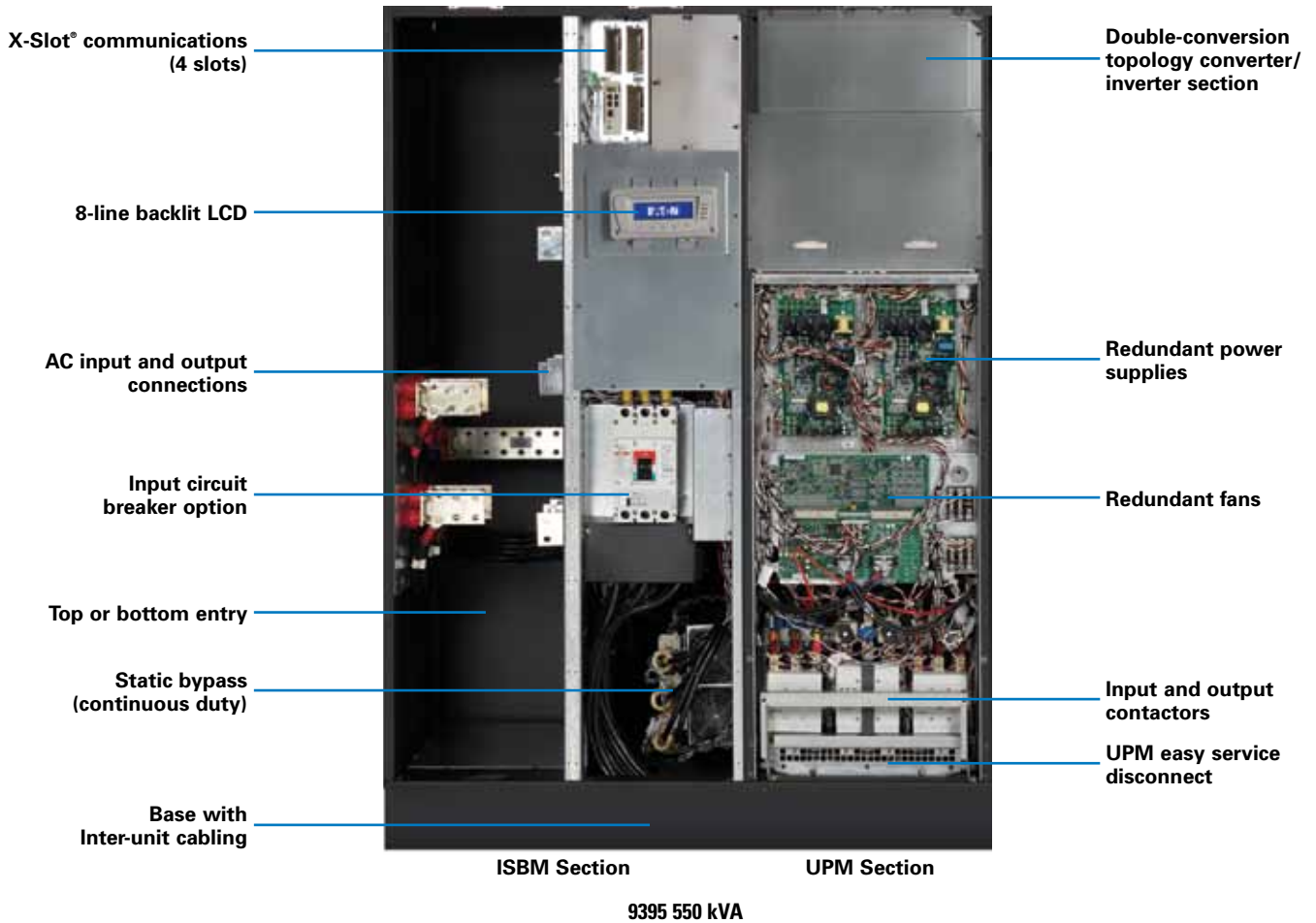

# Technical specifications<sup>2</sup>

## UPS rating (0.9 power factor)

kVA	225	275	450	500	550	650	750	825	1000	1100
kW	202	250	405	450	500	585	675	750	900	1000

## General characteristics

Efficiency	>94% (99% with ESS)
Parallel capability	4 distributed, 32 with SBM
Max modules per size	Up to 3 modules, 550 kVA, up to 4 modules, 825/1100 kVA
Audible noise	<76dBA @ 1 meter
Altitude (max)	2000m at 40°C (104°F)
N+1 redundancy capable	Yes
Field upgradeable	Yes
System bypass module	Included

## Input characteristics

Voltage	480V standard; and 400V available
Voltage range	+10% / -15%
Frequency range	45-65 Hz
Power factor	0.99 (minimum)
Input current distortion	<3.5% (no input filter required)
Soft start capability	Yes
Internal backfeed protection	Yes

## Output characteristics

Voltage	480V standard; and 400V available
Regulation	±1%
Inverter	PWM with IGBT switching
Voltage THD	<2% (100% linear load); <5% (non-linear load)
Load power factor range	Up to a .9 power factor leading without derating

## Battery

Battery types	VRLA, AGM, gel, wet cell
Battery voltage	480V
Temperature compensation	Optional
Charging method	ABM technology or float, selectable

## Dimensions and weights

225 kVA, 275 kVA	52.4" w x 32.7" d x 73.6" h	1786 lb
225 kVA redundant, 275 kVA redundant	73.7" w x 32.7" d x 73.6" h	2875 lb
450, 500, 550 kVA	73.7" w x 32.7" d x 73.6" h	2977 lb
450, 550 kVA redundant	103" w x 32.7" d x 73.6" h	4153 lb
Field upgrade module, 225 or 275 kVA	30" w x 32.7" d x 73.6" h	1176 lb
650, 750, 825 kVA	140.9" w x 32.7" d x 73.7" h	5065 lb
650, 750, 825 kVA +1 redundant	170.2" w x 32.7" d x 73.7" h	6365 lb
1000, 1100 kVA	170.2" w x 32.7" d x 73.7" h	6525 lb

## General characteristics

Control panel (LCD)	8 lines x 40 characters
Battery startup	Standard
Frequency conversion	Standard
Multi-language	Standard
Building alarm inputs	5 (galvanic isolated)

## Options

External maintenance bypass	
PDU, RPP and STS	
Maintenance bypass module, matching cabinet, 2/3/4 breaker	
DC disconnects	
65 or 100 kAIC input breakers	

## Certifications

Safety	UL1778, cUL
EMC	IEC 62040-2, EN50091 Class A (restricted access)

## eNotify remote monitoring

24x7 remote monitoring of UPS and battery alarms, daily heartbeat check and monthly report. eNotify requires the PXGX-UPS card and Environmental Monitoring Probe.

## Communications

Software compatibility: Software and Power Xpert Reporting  
 Communications cards: Four communication bays standard. The following connectivity options can be installed at any time:

- PXGX-UPS card (included)
- ModBus RTU card
- AS/400 Relay card
- Industrial Relay card
- Powerware HotSync CAN Bridge card
- Environmental Monitoring Probe (included)
- Modem card

Remote inputs/outputs: Five building alarm inputs and one summary alarm contact (5A @ 120V) standard  
 Remote monitor panel: Eight backlit status indicator lamps plus an audible horn

1. Due to continuing improvements, specifications are subject to change without notice.
2. Please refer to Eaton Power Xpert 9395 technical documents for specific configuration guidelines and features.

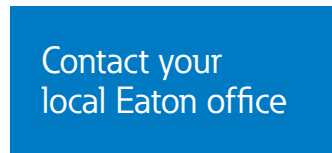

CANADA  
 Ontario: 416.798.0112  
 Toll free: 1.800.461.9166

LATIN AMERICA  
 Aruba: 001 866 898 8812  
 Argentina (South Cone): +5411 4124 4000  
 Bahamas: 1 800 389 0368  
 Brazil: +55 113616 8500  
 Colombia: 01 800 518 1490  
 Costa Rica: 0 800 012 1716  
 Dominican Republic: 1 888 751 4862  
 Ecuador: from Andinatel: 1 999 170 (code after 800 is WSC 5649)  
 El Salvador: 800 6772  
 Mexico: + 52 (55) 9000-5252 or 01 800 08 EATON (32866)  
 Miami: 1 866 248 2224  
 Guatemala: 1 800 624 0099  
 Jamaica: 800 534 2102  
 Nicaragua: 001 800 220 1992  
 Panama: 00 800 226 6524  
 Peru: 0 800 54 514  
 Puerto Rico: 1 877 740 1707  
 Trinidad & Tobago: 1 800 206 0981  
 Venezuela: 0 800 100 8474

**Eaton Corporation**  
 Electrical Sector  
 1111 Superior Avenue  
 Cleveland, OH 44114 USA  
 Eaton.com

© 2012 Eaton Corporation  
 All Rights Reserved  
 Printed in USA  
 9395FXA  
 May 2012



Eaton, Powerware and Power Xpert are trade names, trademarks, and/or service marks of Eaton Corporation or its subsidiaries and affiliates.

All other trademarks are property of their respective owners.